

ACCRA 2 WAY

Table Base

ORIGIN: China **USE:** Indoor **WARRANTY:** 12 Months

DIMENSIONS:

H730 Table

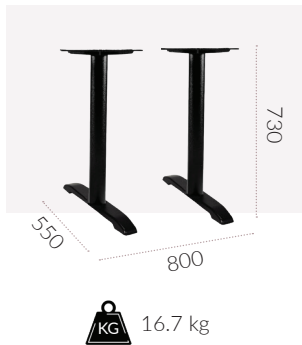

CODES:

Black - BTAC2WBK

FINISHES:

Cast Iron



Black
Textured

ACCRA 2 WAY

Table Base

SPECIFICATIONS:

Spider:

Hole Depth: 7mm

Footprint:

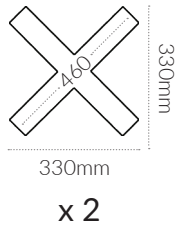

Assembly:

[Plate & Screw -->](#)

Column:

Diameter : 76mm

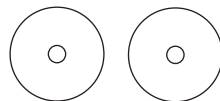

Top

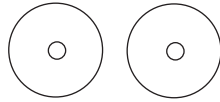

Bottom

Base:

Footprint:

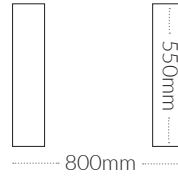

Adjustable Footglides:

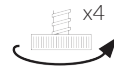

x4
Thread: M10
Length: 12mm

Top Max:

Table:

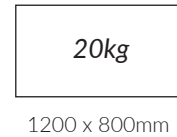

PRODUCT MAINTENANCE:

Cast Iron:

1. Regularly dust surface with damp cloth.
2. Wash with a soft cloth and warm soapy water.
3. Always dry with a lint free cloth.

DO NOT: Use abrasive pads, brushes, or cleaners like steel wool, as it will scratch the surface.

DO NOT: Use powder, concentrated detergents, or silicone-based furniture polishes.

NOTE: Cast iron will oxidize near salt water even in indoor environments, the performance of the item is unaffected, simply follow cleaning instructions.